

# The Semantics of Jitter in Anticipating Time Itself within Nano-Technology

Michael Heather\*, Nick Rossiter<sup>†</sup> and Dimitris Sisiaridis\*\*

\**Ambrose Solicitors St Bede's Chambers, Jarrow NE32 5JB, UK, michael.heather@cantab.net*

<sup>†</sup>*School of Computing, Engineering and Information Sciences, Northumbria University, NE1 8ST, UK, nick.rossiter@unn.ac.uk, <http://computing.unn.ac.uk/staff/CGNRI/>*

\*\**School of Computing, Engineering and Information Sciences, Northumbria University, NE1 8ST, UK, d.sisiaridis@unn.ac.uk*

**Abstract.** The development of nano-technology calls for a careful examination of anticipatory systems at this small scale. For the characteristics of time at the boundary between classical and quantum domains are quite critical for the advancement of the new technology. It has long been well recognised that time is not absolute even in classical subjects like navigation and dynamics where idealised concepts like mean solar time, International Atomic Time and Newton's dynamical time have had to be used. Time is the data of the Universe and belongs in the semantics of its extensional form. At the boundary between classical and quantum behaviour the uncertainty of time data becomes a significant effect and this is why it is of great importance in nanotechnology, in areas such as the interoperability of different time domains in hardware, where noise in the form of jitter causes a system to behave in an unpredictable fashion, a severe and expensive problem for anticipating how time is to be handled. A fundamental difficulty is that jitter is represented using numbers, giving rise to undecidability and incompleteness according to Gödel's theorems. To escape the clutches of Gödel undecidability it is necessary to advance to cartesian closed categories beyond the category of sets to represent the relationship between different times as adjoint endofunctors in monad and comonad constructions.

**Keywords:** time,jitter,nano-technology,adjointness,monads

**PACS:** 03.65.Ca

## 1. NANO-TIME

Nano-technology has shifted the focus of engineering into that twilight zone between the classical and quantum worlds. What was just 'noise' to a classical technologist of the last generation is now the source and content of the artefacts of everyday life for future generations. The nano-zone has a transitional phase between classical and quantum where quantum effects begin to make themselves felt. Time itself begins to break up and this is what we mean by time jitter, although this is still from a classical viewpoint. The quantum perspective does not distinguish time, space or matter as distinct. They are all fragmenting in the nano-zone on their way to becoming independent variables in the classical world. Here we are just concentrating on the time aspect and have in mind particularly the role of time in information systems at the nano level where jitter data may have to be handled.

## 2. JITTER IN ANTICIPATORY SYSTEMS

Anticipatory systems anticipate their own processes at later times either directly (strong anticipation) or by means of some model (weak anticipation) [8, 9, 20] but what about time systems themselves? The theory of general systems is still usually presented in terms of a monolithic time, the independent variable of coordinate time. Time however is extensional with no separate existence in the intensional universe. Anticipatory systems in nano-technology have a far more complex form than here where we can but scratch the surface of the anticipation of nano- time. Nevertheless anticipatory systems are but one component of general systems theory where the fundamental tenet is that given one system any other system behaves very much the same. We have previously urged at CASYS [15] that strong anticipation is achieved when we are able to encapsulate all activity within one system.

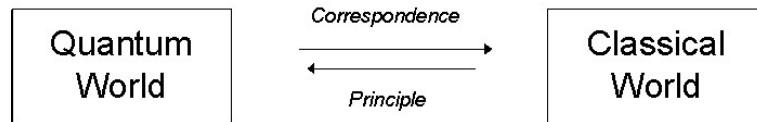

**FIGURE 1.** The Correspondence Principle between Quantum and Classical Worlds

The early development of quantum mechanics was quite within a system's paradigm. The quantum world and the classical world were different ends of the same system with a correspondence between the two as in Figure 1. The use of classical wave mechanics to describe the quantum world has gradually eroded the 'correspondence principle' in an attempt to justify a quantum theory in its own right usually based on some concept of a probabilistic wave function. The view in this direction was mainly driven by modern physics where quantum phenomena are at extremely small scales of length and time and therefore a very long way from the everyday world. The correspondence principle enunciated by Bohr and fellow workers [2] is now referred to as belonging to 'old quantum theory'. However it is difficult to justify these developments in terms of a systems theory with the main tenet that one system is the same as any other. There it is difficult to accept that the quantum world and the classical world are different worlds. It rather leads to a more startling view that if the universe is all one system then the real world is quantum and the classical just a limiting view of certain observable phenomena. This is supported by the evidence that non-physical phenomena like for instance the behaviour of social systems do exhibit quantum-like characteristics in everyday life.

The integration of the classical and the quantum seems to result in a much more realistic and practicable approach to nano-technology which reifies the correspondence principle in engineering terms. The nano-technology occupies the territory of the correspondence principle as shown in Figure 2. In Figure 3, it is emphasised that the nano-world mediates between the quantum and classical world views of the universe.

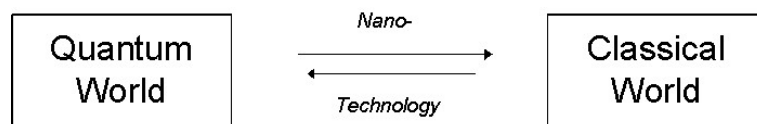

**FIGURE 2.** Nano-technology mediates between Quantum and Classical Worlds

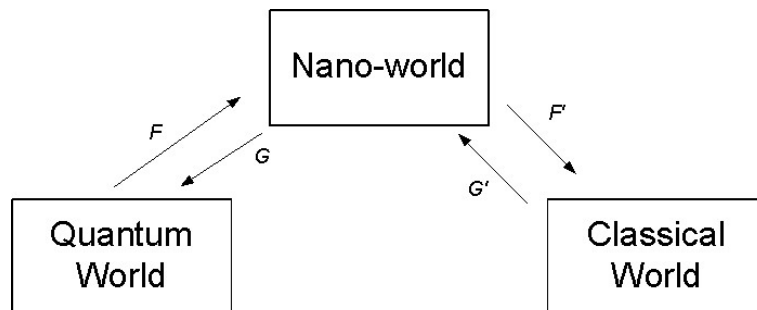

**FIGURE 3.** The Nano-world hypothesized (after Cohen's method of Forcing [6]) between Quantum and Classical Worlds where the Theory of Nano-technology resides

The aim is the utilisation of the power of the quantum world in everyday technology but with this great power comes greater complexity such as time jitter. To those that take a special view of quantum theory, phenomena like the Heisenberg's uncertainty principle are considered special without any classical corresponding classical analogue. This is one point where the systems theory approach becomes controversial. Under the system's paradigm Heisenberg uncertainty is but one example of a much wider class of undecidability which includes the results of Gödel's theorems.

There can be no doubt that there are types of time jitter that have long been recognised as existing in classical systems. Take for example the difference between solar time and sidereal time that has been important for navigators for some centuries and which is discussed further below.

### 3. CLASSICAL TIME JITTER

Time is usually taken as an independent variable in studies of anticipatory systems. For many everyday applications this may be a sufficient assumption but it is only an assumption and the theory of anticipatory systems needs to recognise the status of time. Time is extensional not intensional and there is no such concept as absolute time. This follows directly from Einstein's theories where the fundamental entity is space-time. Time is but a projection in some specific circumstance and then relative to the view of a particular observer. There can therefore be more than one time [16]. The present scientific definition of time is developed axiomatically as a single totally ordered sequence. The fundamental axiom is that the velocity of light has a finite limit, which is the basis of Minkowski space that we inhabit. By convention it is agreed in the *Système Internationale (SI)* that a common standard for the unit of time be derived from two frequency lines in the spectrum of Caesium-133. Other fundamental quantities like length (as a wavelength) are then defined in terms of time as established by this basic standard. However the unit of time itself cannot then be given by any more fundamental physical quantity. The everyday perception of time is bound up with our experience of the motion of the Earth and Sun, with the rotation of the Earth on its axis generating the diurnal motion of the Sun and stars in the sky as an apparent unit of time.

There is a classical time jitter between the diurnal motion of the Sun and that of a star - solar time and sidereal time. This jitter arises because the Sun's motion is both elliptical and in the ecliptic. That is the Sun appears to move as though the Earth is situated in one focus on an ellipse but not then in the equatorial plane with respect to rotation but at an inclined angle, that is the plane of the elliptic. The two units of time are therefore different and irregular over the sidereal or solar because motion around an ellipse does not sweep out equal angles in equal time. There are also higher-order variations long-term (by procession) and short-term (by mutation) both arising from consideration of the Sun-Moon dynamics because the Earth is an oblate-spheroid with a slightly greater equatorial than polar radius which would be equal for a sphere. The regularity is ironed out by using the concept of a 'dynamical mean sun' with average values. So a relative difference is that a sidereal day corresponds to  $23^h56^m4^s.09053$  of mean solar time while the mean solar day corresponds to  $24^h3^m56^s.55537$  of mean sidereal time ([13] p.242; [25] p.141-144).

Astronomy recognises six fundamental different time bases ([13] chapter 10): sidereal time, solar time, atomic time, dynamical time, proper time and coordinate time, as well as variants on them. Dynamical time is the independent variable of the equations of motion (including gravity) based on Newtonian physics. This is replaced by ephemeris time (ET) <sup>1</sup> for observational purposes where the fictitious Ephemeris Mean Sun (EMS) moves uniformly around the equator with the mean motion of the true Sun. This requires a fictitious ephemeris meridian with a slow eastward drift ([13] p.238).

On the other hand atomic time is standardised as International Atomic Time (TAI) which is the fundamental unit of the SI second and is the same second as defined in terms of the oscillation of the Caesium atom <sup>2</sup>. TAI and ET are independent but formally defined on the same time-scale. However even these time scales would vary if as some suggest the gravitational constant G is subject to secular weakening [7]. Proper time is defined along the geodesic of the world line as defined in general relativity for an earthbound observer. Coordinate time is the general relativity counterpart to the Newtonian dynamic time. It is not unique but chosen by convention recognised under the International Astronomical Union (IAU); Terrestrial Dynamical Time (TDT) is based on the SI second. TDT differs from Barycentric Dynamical Time (TDB), as needed for equations of motion of the planets with respect to the barycentre of the solar system. TDB and TDT are related by the judicious choice of the zero point and scaling factor in coordinate time. Stephenson [26] discusses the long-term variation in time related to the fluctuation of the earth's rotation but without the details of short-term causes.

Diurnal motion itself is not uniform because the rotation of the Earth is not constant. There are minute fluctuations probably arising from motion within the Earth's molten core but there is also a secular deceleration of about  $10^{-3}$  seconds per day per century. This is measurable from ancient records of solar eclipses where the zone of totality is displaced by several hundred miles from that anticipated in the past calculated on present day astronomical units [14, 26]. There is no universal time <sup>3</sup>.

Classically the time jitter between solar and sidereal time is expressed in the equation of time. This applies for

---

<sup>1</sup> ET is used since 1960 for the ephemerides in the annual almanacs. The difference between ET and UT is irregular with the earth's rotation.

<sup>2</sup> Even then the definition of the Caesium atom is defined for its frequency oscillation of the Caesium atom on the Earth's surface.

<sup>3</sup> The term Universal Time is used by some as an alias for Greenwich Civil Time or Greenwich Mean Time, that is the time observable from the Greenwich meridian. Rather ironically those who object to recognising the time in England as a fundamental standard have chosen to bestow on it the even more grand title of Universal Time!

practical purposes in observation for navigation, which needs to be by reference to meridians related to the Earth's equator. For while the dynamical mean Sun is a fictitious sun averaging the true motion along the ecliptic, a further notional concept of the corresponding 'mean sun' along the equator is needed. The equation of time is therefore defined as the difference between the right ascension of the mean sun and the Sun's observed right ascension. The equation of time varies throughout the year from approximately  $-14\frac{1}{4}$  minutes to  $+16\frac{1}{4}$ . This is classical time jitter where the mean sun coincides with the observed value of the Sun four times a year ([24] Figure 36 at p.66). It should be emphasised that the equation of time cannot be determined in advance, only by observational experiment at any instant of time. All probabilistic systems in the real-world are deterministic with hindsight. This is the nature of exactness [23].

#### 4. TIME IN EVENTS

These methods needed to treat time in astronomy and navigation well illustrate the point that time is not absolute. There follows the conclusion which is rather startling at first sight with regard to the nature of events. Events do not happen in time: time happens in events. This was perhaps not fully realised throughout the twentieth century but nevertheless is quite clearly necessary in the theories of Relativity and Quantum Mechanics and evident early on in the work of Alfred North Whitehead. Although Whitehead's theory of process seems some way from relativity, his collaborator Russell writing some years later [22] says of the period when they were working together in the early 1900's:

Dr. Whitehead, at this stage, persuaded me to abandon points of space, instant of time, and particles of matter, substituting for them logical constructions composed of events. In the end, it seemed to result that none of the raw material of the world has smooth logical properties, but that whatever appears to have such properties is constructed artificially in order to have them.

This is really quite remarkable because it seems that Russell anticipated Einstein's theories of relativity as well as quantum mechanics including the non-continuous nature of space, time and matter. It may well have been in accordance with these sentiments that Whitehead later rather turned his back on his not inconsiderable logico-mathematical work in favour of philosophy, espousing the cause of 'process' as initiated by the French philosopher Henri Bergson [1]. Whitehead's exposition on 'Process and Reality' was given as the Gifford lecture for 1927 [28]. There Whitehead developed further his notion of an event in a more systematic fashion (but not in formal mathematics) as an 'actual entity' operating under 'prehension'. Without formal definitions his concepts like actual entity and prehension appear rather obscure. Now with the understanding of 'adjointness' in category theory [18, 15] we can recognise Whitehead's 'actual entity' with 'prehension' as an adjointness between his 'process' and 'reality' as in Figure 4. In that figure the overloaded multiplication and addition signs represent respectively exactness and co-exactness. There is an ordering relationship between the natural limit as a preorder of left exactness in matter and space with the dual coexact right co-limit as a partial order of the separate space dimensions and matter that we seem to perceive in reality. The 'that we seem to perceive' is a further complication which we need to understand in terms of the logic of Husserl's phenomenology [17, 4], but not here. It seems that perhaps the reality of nanotechnology can help us with a better understanding of the philosophical concepts of process phenomenology.

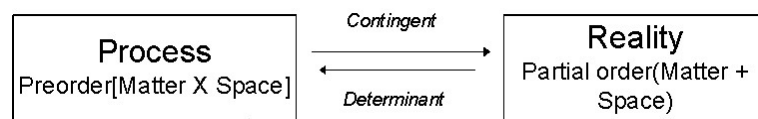
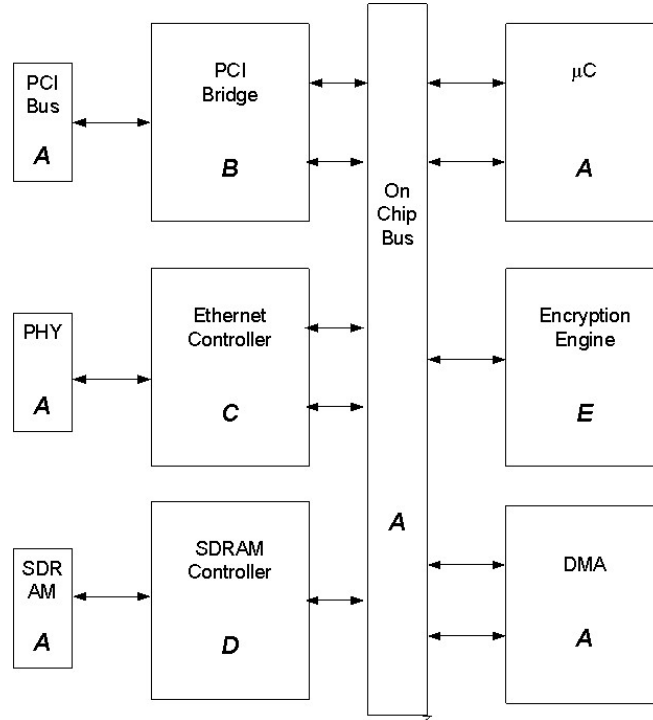

**FIGURE 4.** Whitehead's 'actual entity' and 'prehension' as adjointness between his Process and Reality

From Figure 4 we can see that jitter in reality whether in space, time or matter arises from perturbation in the state of process order in the world. A prime example is the observational effect of a gravitational wave passing as a jitter in time-ordered matter and space. However this predicted effect is yet to be reported [3].

## 5. NANOTECHNOLOGY EXAMPLE

In nano-phenomena where different time becomes apparent it is necessary to anticipate time data independent of time itself (or themselves). A prime example in current nanotechnology is the interoperability of different time domains in the ASIC (Application-Specific Integrated Circuit) hardware presently available. In the example shown in Figure 5, from [5] for a network transport system, there are multiple different clock domains numbering five in all: A, B, C, D and E. The components included in each domain are shown in the figure. The On-Chip Bus itself,  $\mu C$  the controller, DMA (Direct Memory Access), PCI (Peripheral Component Interconnect) Bus, PHY (a generic integrated circuit) and SDRAM (Synchronous Dynamic Random Access Memory) are included in domain A; the PCI Bridge in domain B; the Ethernet Controller in domain C; the SDRAM Controller in domain D and the Encryption Engine in domain E. A lack of synchronicity results from many different clock signals transferring data from one domain to another, giving rise to uncertainty in communication near the signal boundaries.



**FIGURE 5.** Example of the Interoperability Required for Different Clock Time Domains, shown in bold italics

## 6. CLASSICAL TREATMENT OF THE PROBLEM

The practice in industry is to treat the uncertainty as noise and to provide a clock conditioner designed to generate an ideal time based on a classical model (and therefore presumably using Newtonian dynamic time) for a sinusoid oscillator additive phase noise,  $\phi_N(t)$ , using the equation below (2.28 in [19]) with  $t$  as time and other symbols defined below:

$$v(t) = V_0 \sin(\omega_0 t + \phi_N(t)) = V_0 \sin\left\{\omega_0\left(t + \frac{\phi_N(t)}{\omega_0}\right)\right\} = V_0 \sin(\omega_0(t + \tau_j))$$

It follows that the (weak) anticipatory time correction is  $\tau_j = \phi_N(t)/\omega_0$ . Amplitude noise in addition to additive phase noise may be expressed as  $v(t) = V_0(1 + m(t))\sin(\omega_0 t + \phi_N(t))$  with the optimal behaviour given by  $v(t) = V_0(\sin(\omega_0 t))$  where the oscillator output  $v(t)$  is a perfect sinusoid of amplitude  $V_0$  and frequency  $\omega_0$ . This provides a higher order component of anticipation.

The capture of time data at this level exhibits the limitations of weak anticipation derived by statistical data modelling. The noise gives rise to jitter which is a measure of the displacement from the anticipated phase cycle: jitter is the variation in the cycle time of a signal between adjacent cycles.

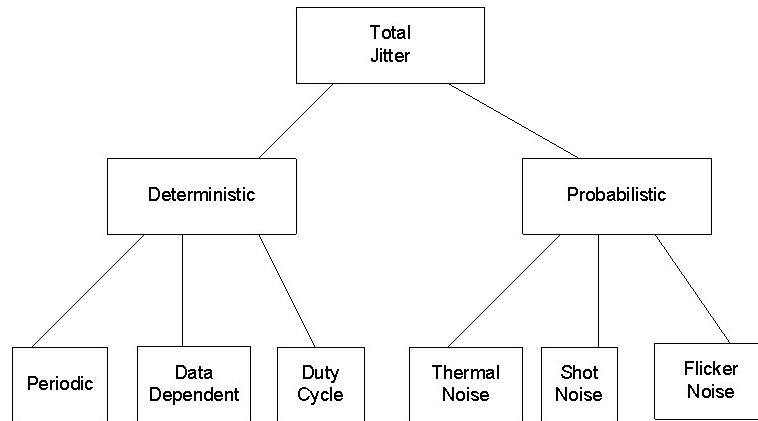

**FIGURE 6.** Taxonomy for Cycle-to-Cycle Period Jitter

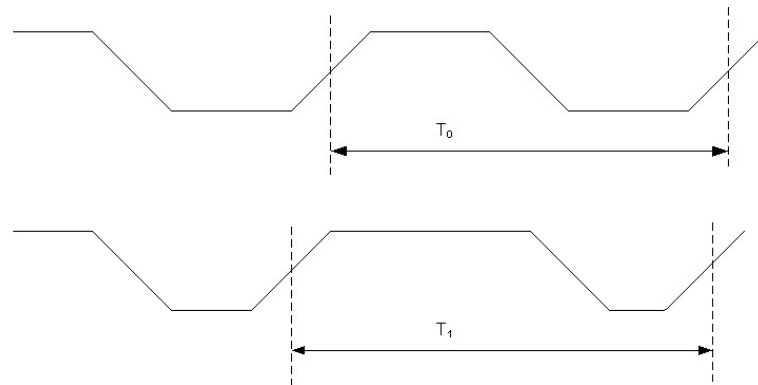

**FIGURE 7.** Period Jitter. Top line – ideal or perfect process clock waveform; bottom line notional clock.  $T_0 = 1/f_0$ ,  $T_1 = t_\tau$ , jitter =  $T_1 - T_0 = t_\tau - 1/f_0$ ,  $\tau$  is relaxation time

Figure 6 shows a taxonomy of the two main components of jitter, to be found in the literature, namely deterministic and probabilistic. Figure 4 suggests that these arise respectively from contravariant and covariant distinctions in the adjointness between *process* and *reality*. The former relates to bounded behaviour that is predictable and determinable, the latter to unbounded behaviour such as phase noise. Bounded behaviour is in turn comprised of three main components: periodic from data interferers and spurious signals, data dependent from data patterns and duty cycle from circuit non-linearities. Random behaviour may arise in phase noise from thermal, shot or flicker sources. Figure 7 shows how jitter arises through slight differences between some reference and some actual clock. Jitter is not just a theoretical problem. Because of its unpredictable nature it can cause chips to behave in an unreliable manner resulting, after the chip has been incorporated as a component of a production system, in expensive re-engineering of the design.

## 7. DIFFICULTIES CAUSED BY AXIOMS AND NUMBERS

The classical approach to jitter using the equations above is based on numbers. Therefore according to Gödel's theorems such equations suffer from undecidability and incompleteness. In a single local time system, jitter may not be a problem but it is an inevitable problem in multiple time systems where interoperability is required with higher-order operations.

The time anomalies described earlier arise from attempts to measure a system with numbers, when that system relies on assumptions. The anomalies are those expected from Gödel's theorems on undecidability [12]. Just because

for practical purposes it is possible to make assumptions, these are really only valid for local conditions. Satisfying local conditions only is an example of another of Gödel's results namely that first-order predicate calculus is complete [10, 11] but only locally. The local time given as a particular meridian <sup>4</sup> has always been important for navigation purposes. Radio and TV have difficulties in giving the time to their audience across different time zones. The BBC World Service after experimenting with attempts to provide local time to various zones of its listeners has recently returned to its traditional practice of using GMT everywhere all the year round.

The theorems of Gödel are very relevant to the theory of anticipatory systems because time is fundamental to them. Classical methods of formal mathematics give only weak anticipation which is subject to Gödel undecidability and consequently of limited use for nanotechnology which needs the techniques of strong anticipation. Pure category theory has been developed in an axiomatic manner to handle all types of category, whether cartesian closed or not. The use of pure category theory may therefore still lead us into situations where constructions are undecidable. Applied category theory using cartesian closed structures is based on categories with natural stability, not requiring an axiomatic framework. In an attempt to avoid undecidability we therefore now advance to mathematical cartesian closed categories beyond the category of sets.

## 8. CATEGORIAL SOLUTION

The advanced categorical form is seen to call for the use of adjointness where time jitter is measurable as the unit and count of adjunction. These measures are not a number and are therefore free of the difficulties such as undecidability attributed by Gödel to numbers. They are similar to those used to achieve simultaneity in database transactions as described by [21]. In the categorical view, time is part of the data and is with the system, not an external parameter. To anticipate time is a semantic operation, not a syntactic one.

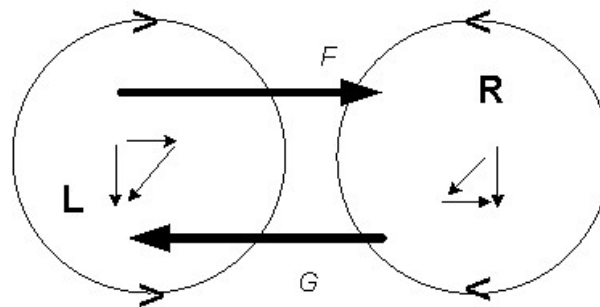

FIGURE 8. Adjointness between Functors  $F$  and  $G$  mapping Categories  $\mathbf{L}$  and  $\mathbf{R}$

In Figure 8 two categories are shown,  $\mathbf{L}$  and  $\mathbf{R}$ . Between the categories there are two functors  $F : \mathbf{L} \rightarrow \mathbf{R}$  and  $G : \mathbf{R} \rightarrow \mathbf{L}$ . If  $\mathbf{L}$  and  $\mathbf{R}$  represent different time systems then the functors  $F$  and  $G$  give the mappings between the two systems. If the two time systems are not in complete synchronisation, the normal situation, then  $l \rightarrow GF l$  and  $F G r \rightarrow r$ , where  $l$  is an object in category  $\mathbf{L}$  and  $r$  an object in category  $\mathbf{R}$ , are not identities. There may still be a relationship in that the shift from an object in one category to another object in the same category after applying the two functors in turn is measurable using the triangles shown inside the categories. Although the triangles are drawn this way it should be noted that, as they are higher-order arrows, they actually transcend the categories. This relationship is adjointness, written  $F \dashv G$ . If the conditions of the two triangles are not met, then the functors are not adjoint one to another.

The two commuting triangles that satisfy adjointness integrate ordinary arrows  $f$  and  $g$  within categories  $\mathbf{L}$  and  $\mathbf{R}$  respectively together with the higher functor arrows  $Gg$  and  $Ff$  between the two categories with the highest level natural transformation arrows  $\eta$  and  $\epsilon$ , which coordinate the relationship between the two categories from their

<sup>4</sup> On land, developments in transport like the coming of the railways meant that a Standard Time or Zone Time became more important than an accurate local time but only when there was a small time jitter between the two. This has given rise to the time zones around the Earth at 15 degrees that is one hour intervals. This shows the dominant effect of natural conditions. Trains work to the nearest time zone but aeroplanes need different time zones.

respective viewpoints. In more detail Figure 9 shows the objects and arrows involved in each triangle with 9(a) showing the situation in category  $\mathbf{L}$  and 9(b) that in category  $\mathbf{R}$ . The unit of adjunction  $\eta : l \rightarrow GF l$  gives the displacement in  $\mathbf{L}$  and the counit of adjunction  $\varepsilon : FG r \rightarrow r$  that in  $\mathbf{R}$ . Time jitter is measurable as the unit of adjunction and the counit of adjunction. These measures (units) are not a number and are therefore Gödel free. Coherence occurs [23] when the two triangles are satisfied, that is they both compose with  $Gg \circ \eta = f$  in (a) and  $\varepsilon \circ Ff = g$  in (b).

If the two systems are completely in synchronisation then the two functors  $F$  and  $G$  are equivalent with  $\mathbf{1}_{\mathbf{L}} : l \rightarrow GF l$  and  $\mathbf{1}_{\mathbf{R}} : FG r \rightarrow r$  both identities. In this case the triangles shown inside the two categories in Figure 8 become reduced to a single arrow each. In  $\mathbf{L}$   $f$  is equivalent to  $Gg$  and in  $\mathbf{R}$   $g$  is equivalent to  $Ff$ .

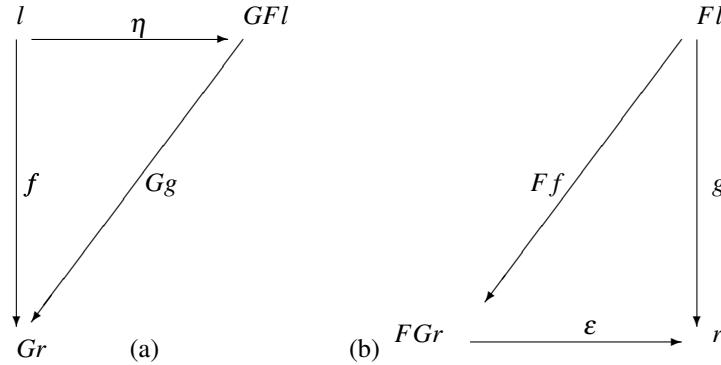

**FIGURE 9.** Roles in Adjointness of a)  $\eta$ , the unit and b)  $\varepsilon$ , the counit of adjointness respectively

Looking at the earlier diagram in Figure 7 the interpretation of jitter, represented as  $t_\tau - 1/f_0$  in [19], in categorical terms is given by the unit and counit of adjunction. The unit of adjunction  $\eta$  gives the displacement from the point of view of process order with  $F$  selecting a different periodicity; the counit of adjunction  $\varepsilon$  gives the displacement from the point of view of notional time with  $G$  accepting a change to the periodicity selected by  $F$ .

Figure 10 shows the adjoint relationship between the functors  $F$  and  $G$ , the former mapping the category for process order to that for Notional Time and the latter mapping the category for Notional Time to that for Process Order. The unit and counit of adjunction are also shown in this figure.

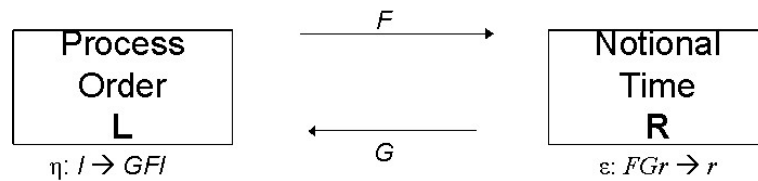

**FIGURE 10.** Adjoint Relationship between Categories for process order and for Notional Time

There are a number of similarities between the techniques used here to achieve coherence in time with those used to achieve simultaneity in database transactions [21]. There is always some undecidability about the outcome as in transactions. While many aspects are deterministic, there are always non-deterministic features, which means that we cannot completely decide how time or a transaction will behave. The random part is undecidable and forms part of our understanding of the overall situation.

Figure 11 is an expansion of Figure 8 to show how, after one cycle, an arrow  $f : l \rightarrow Gr$  in  $\mathbf{L}$  is converted to  $f^\sharp : Fl \rightarrow r$  in  $\mathbf{R}$ . The unit of adjunction  $\eta$  gives the displacement in  $\mathbf{L}$  and the counit of adjunction  $\varepsilon$  that in  $\mathbf{R}$ . This gives coherence in time. If  $\eta$  maps onto  $\perp$  and  $\top$  maps onto  $\varepsilon$  then there is the special case of equivalence between the functors  $F$  and  $G$ , that is synchronisation of time. However, from the point of view of jitter, the single cycle of Figure 11 is not enough. This shows preliminary values for  $\eta$  and  $\varepsilon$  from changes to process order. A second cycle<sup>5</sup> is needed as shown in Figure 12 to revise values for  $\eta$  and  $\varepsilon$  after considering changes to notional time.

A third cycle is needed to produce final values for  $\eta$  and  $\varepsilon$  by closure of the previous two cycles. The third cycle therefore finalises the displacements of notional and process order for interoperability, enabling jitter to be handled in a coherent manner. The minimum number of cycles to achieve consistency is three [21].

<sup>5</sup> While the events can be conceptualised as a sequence of cycles, the changes are actually performed with simultaneity.



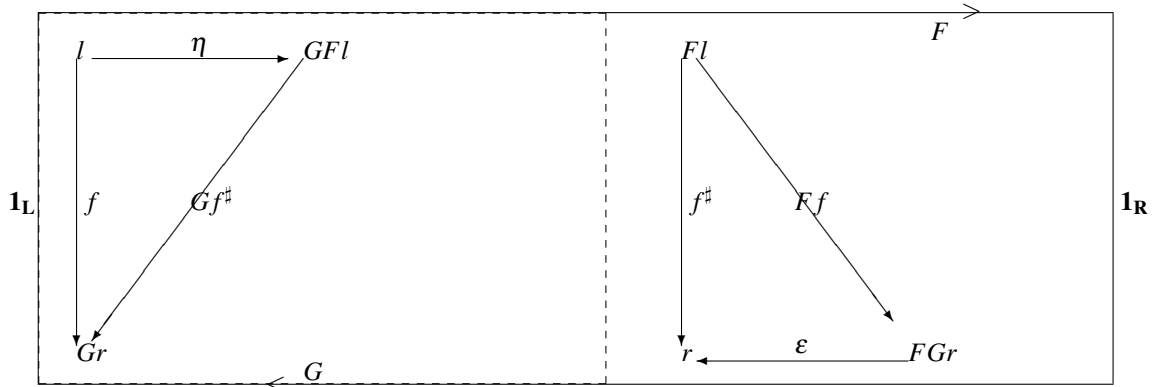

**FIGURE 11.** After one cycle  $GF$  from left-hand category and one cycle  $FG$  from right-hand category:  $\eta$  maps onto other than  $\perp$  and  $\top$  maps onto other than  $\varepsilon$

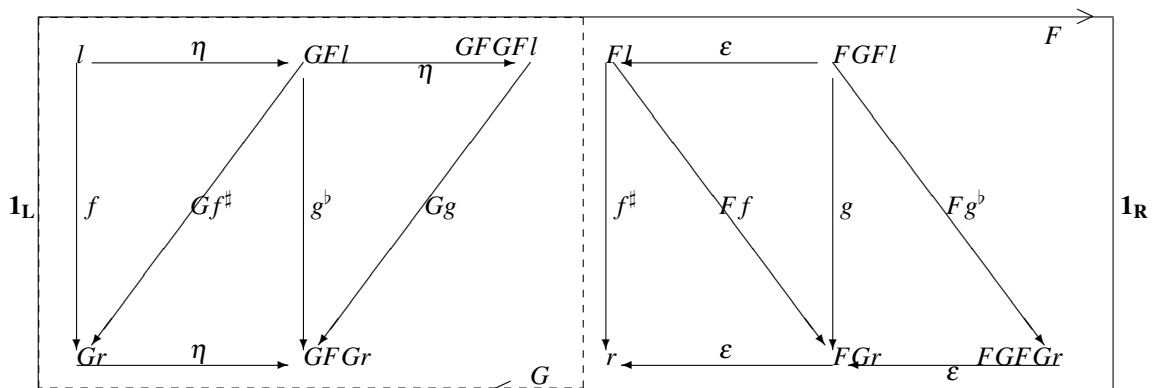

**FIGURE 12.** After two cycles  $GFGF$  from left-hand category and two cycles  $FGFG$  from right-hand category:  $\eta$  maps onto other than  $\perp$  and  $\top$  maps onto other than  $\varepsilon$

The result after three cycles  $GFGFGF$  can be shown by an addition to Figure 12 and indeed this is done later but the diagram now becomes complex and it is convenient to move to the language of monads ([18] p.137-142) to underpin our conceptual ideas. Even with this greater sophistication though we are not tackling the whole problem shown in Figure 3 where a composition of distinct functors needs to be handled. A monad is sometimes described as a triple<sup>6</sup>, comprising an endofunctor say  $T$ , the unit of the monad  $\eta$  and the multiplication of the monad  $\mu : T^2 \rightarrow T$ :

$$\text{Monad} = \langle T, \eta, \mu \rangle$$

A pair of adjoint functors is an endofunctor: in this case the source category of  $F$ ,  $\mathbf{L}$ , is also the target category of  $G$ . So for the endofunctor  $T$  as the pair of adjoint functors  $GF, F : \mathbf{L} \rightarrow \mathbf{R}$  and  $G : \mathbf{R} \rightarrow \mathbf{L}$ :

$$\text{Monad} = \langle GF, \mathbf{1}_L \rightarrow GF, GFGF \rightarrow GF \rangle$$

where  $\mathbf{1}_L \rightarrow GF$  is the unit of the monad and  $GFGF \rightarrow GF$  is the multiplication. For the monad to exist, the diagrams in Figure 13 must commute. A fuller explanation of these diagrams can be found at [21]. The monad construction with adjoint functors  $GF$  as the endofunctor provides a number of constraints very relevant to time:

1. There is a unique solution, ensuring reproducibility, through the adjointness  $F \dashv G$ .
2. The change in process order looking forward is represented by the unit of adjunction  $\eta$ ; if  $\eta$  maps onto the initial object  $\perp$  then there has been no change.
3. The change in process order looking back is represented by the multiplication  $\mu : T^2 \rightarrow T$ , that is  $G\varepsilon F$ . If  $G\varepsilon F$  maps onto  $\text{id}_{T^2}$  then there has been no change in process order. Otherwise there is a change represented by  $\eta$ .

<sup>6</sup> However, this is not a tuple or ordered set because  $T, \eta, \mu$  are not independent elements.

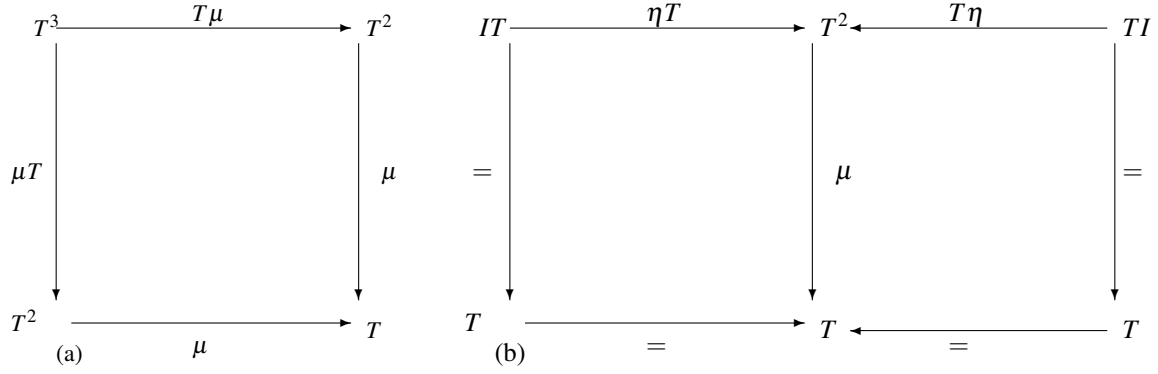

**FIGURE 13.** (a) Associative Law for Monad  $\langle T, \eta, \mu \rangle$ ; (b) Left and Right Unitary Laws for Monad  $\langle T, \eta, \mu \rangle$

4. The arrow  $T\mu : T^3 \rightarrow T^2$  in Figure 13(a) is a natural transformation comparing the second and third cycles from the viewpoint of the third cycle, that is looking back.  $T\mu$  is  $GFGEF$  ([18], p. 138). If  $GFGEF$  maps onto  $\text{id}_{T^3}$  then there is no change in process order. Otherwise there is a change represented by  $\eta$ .

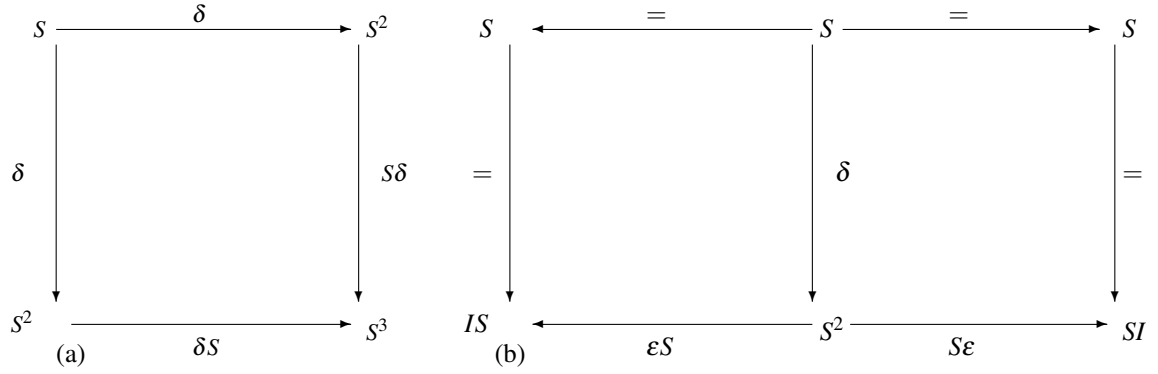

**FIGURE 14.** (a) Associative Law for Comonad  $\langle S, \varepsilon, \delta \rangle$  (b) Left and Right Unitary Laws for Comonad  $\langle S, \varepsilon, \delta \rangle$

The monad gives the left-hand perspective. There is also a dual comonad which gives the right-hand perspective, necessary to represent the changes to notional time. A comonad is a triple, comprising an endofunctor say  $S$ , the counit of the comonad  $\varepsilon$  and the comultiplication of the comonad  $\delta : S \rightarrow S^2$ :

$$\text{Comonad} = \langle S, \varepsilon, \delta \rangle$$

A pair of adjoint functors is an endofunctor: in this case the source category of  $G$ ,  $\mathbf{R}$ , is also the target category of  $F$ . So for the endofunctor  $S$  as the pair of adjoint functors  $FG, G : \mathbf{R} \rightarrow \mathbf{L}$  and  $F : \mathbf{L} \rightarrow \mathbf{R}$ :

$$\text{Comonad} = \langle FG, FG \rightarrow \mathbf{1}_{\mathbf{R}}, FG \rightarrow FGFG \rangle$$

where  $FG \rightarrow \mathbf{1}_{\mathbf{R}}$  is the counit of the comonad and  $FG \rightarrow FGFG$  the comultiplication. For the comonad to exist, the diagrams in Figure 14 must commute. The comonad construction with adjoint functors  $FG$  as the endofunctor provides a number of constraints very relevant to time:

1. There is a unique solution, ensuring reproducibility, through the adjointness  $F \dashv G$ .
2. The change in notional time looking back is represented by the counit of adjunction  $\varepsilon$ ; if the terminal object  $\top$  maps onto  $\varepsilon$  there has been no change.
3. The change in notional time looking forward is represented by the comultiplication  $\delta : S \rightarrow S^2$ , that is  $F\eta G$ . If  $\text{id}_S$  maps onto  $F\eta G$  there has been no change in notional time. Otherwise there is a change represented by  $\varepsilon$ .

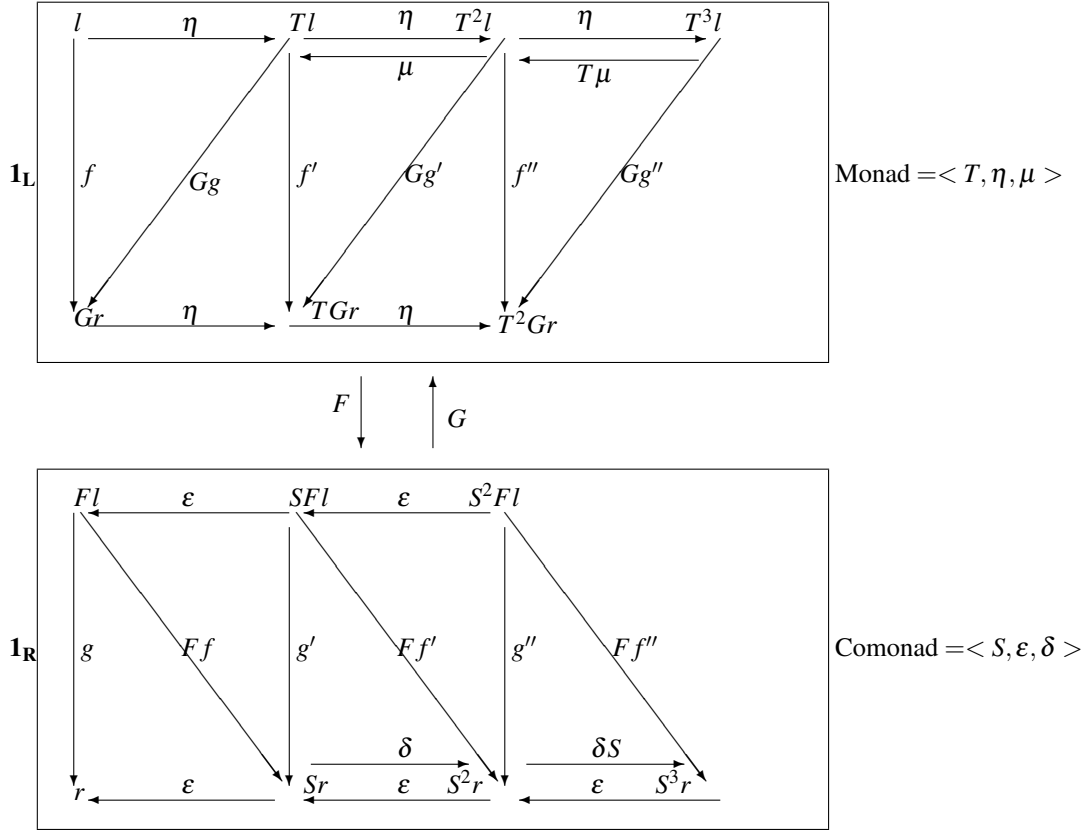

**FIGURE 15.** After three cycles  $GFGFGF$  from left-hand category and three cycles  $FGF\eta G$  from right-hand category:  $\eta$  and  $\delta$  map onto other than  $\perp$ ,  $\top$  maps onto other than  $\epsilon$  and  $\mu$

4. The arrow  $\delta S : S^2 \rightarrow S^3$  in Figure 14(a) is a natural transformation comparing the second and third cycles from the viewpoint of the second cycle, that is looking forward.  $\delta S$  is  $FGF\eta G$ . If  $\text{id}_{S^2}$  maps onto  $FGF\eta G$  there is no change in notional time. Otherwise there is a change represented by  $\epsilon$ .

Finally we combine the monad approach with the more detailed approach of Figure 12. The motivation for the combining of the two approaches is to provide an architecture for comparing the times in detail, perhaps at a level approaching that of a constructive or functional program in computing science, while maintaining the more abstract approach of monadic category theory. Compared to Figure 12, Figure 15 shows an additional cycle bringing the total number of cycles to three, together with the arrows for multiplication  $\mu$  and comultiplication  $\delta$ . The notation has been revised to match that of monads and comonads with  $T = GF$  and  $S = FG$ . For generality the family of arrows for  $f$  and for  $g$  are distinguished by primes ( $'$ ) rather than by  $\sharp$  or  $\flat$ . The adjoint functors  $F$  and  $G$  mapping between the monad and the comonad are both contravariant.

The diagram in Figure 15 handles the time interoperability problem as follows. There is a unique solution, ensuring reproducibility, through the adjointness  $F \dashv G$ . The displacements in process order  $\eta$  and in notional time  $\epsilon$  are given by the monad and comonad respectively. If there is no displacement in process order or notional time, that is  $\eta$  maps onto  $\perp$  and  $\top$  maps onto  $\epsilon$ , then the relationship is the special case of equivalence between  $F$  and  $G$  and the times are synchronised. Determinism is measured through the arrow  $\mu : T^2 \rightarrow T$  (looking back). Closure is achieved through the third cycle with  $T\mu$  ( $GFG\epsilon F$ ) comparing the second and third cycles from the viewpoint of the third cycle (looking back) and  $\delta S$  ( $FGF\eta G$ ) comparing the second and third cycles from the viewpoint of the second cycle (looking forward). If  $GFG\epsilon F$  maps onto  $\text{id}_{T^3}$  and  $\text{id}_{S^2}$  maps onto  $FGF\eta G$  then the relationship is the special case of equivalence between  $F$  and  $G$  and process order and notional time are synchronised. Anticipation is measured through the arrow  $\delta : S \rightarrow S^2$  (looking forward). This arrow as a free functor is non-deterministic. The anticipation is strong as it is achieved through the system itself, not through a model. Indeed  $\delta$  is the fundamental unit of anticipatory systems.

## 9. CONCLUSIONS

It can be seen from Figure 15 that time can be defined absolutely as a natural ordering using the property of adjointness between monads and comonads from category theory. Interestingly with developments in functional programming languages such as Haskell, where the monad is being realised as a first-class abstract data type [27], it is now possible to implement the structures developed here directly as a computer program. Returning to Figure 3 nano-technology can be seen as the composition of the two adjunctions  $F \dashv G$  and  $F' \dashv G'$ . In theory it is believed that three such composed adjunctions are necessary to define a system with closure, as reported in [20]. The monad/comonad approach of this paper also confirms that composition of three adjunctions delivers natural closure but in this case the functors are endofunctors.

## REFERENCES

1. Bergson, Henri, *Essai sur les Données Immédiates de Conscience* (1889); Time and Free Will: An Essay on the Immediate Data of Consciousness, translated F L Pogson, Kessinger (1910).
2. Bohr, N, *Niels Bohr Collected Works V.3*, The Correspondence Principle (1918-1923), edd J R Nielsen, L Rosenfeld, North Holland (1976).
3. Caltech/MIT, Laser Interferometer Gravitational-Wave Observatory, <http://www.ligo.caltech.edu/> (2002).
4. Cheung, Chan-Fai & Yu, Chung-Chi (edd 1), Loparic, Zeljko & Walton, Roberto (edd 2), Copoeru, Ion & Sepp, Hans Rainer (edd 3 & 4), Embree, Lester & Nenon, Thomas (edd 5), *Phenomenology 2005* Zeta Books (2007).
5. Cohen, D. & Banks, C, Taking the Risk out of Multi-clock Design, *Electronics Weekly* no. 2282 04.04.07 p.24-28 (2007).
6. Cohen, P J, The Independence of the Continuum Hypothesis, *Proc Nat Acad Sci USA* I. **50** 1143-1148 (1963), II **51** 105-110 (1964).
7. Dicke, R H, Gravitational Theory and Observation, *Phys Today* **20** 55-70 (1967).
8. Dubois, D M, Review of Incursive, Hyperincursive and Anticipatory Systems - Foundation of Anticipation in Electromagnetism. *CASYS'99 - Third Int Conf*, Dubois, D M, (ed), AIP Conference Proceedings **517** 3-30 (2000).
9. Dubois, Daniel M, Mathematical Foundations of Discrete and Functional Systems with Strong and Weak Anticipations, in: Anticipatory Behavior in Adaptive Learning Systems, State-of-the-Art Survey, Edited by Martin Butz *et al*, *Lecture Notes in Artificial Intelligence*, Springer **2684** 110-132 (2003).
10. Gödel, Kurt, *Über die Vollständigkeit des Logikkalküls* Doctoral Thesis, D1.736 33pp, University of Vienna (1929). Reprinted in Feferman, S, ed. Gödel Collected Works, volume 1, publications 1929-1936, Oxford, p.60-100 (even numbers) original; p.61-101 (odd numbers) translators Bauer-Mengelberg, Stefan, & Heijenoort, Jean van (1986).
11. Gödel, Kurt, Die Vollständigkeit der Axiome des logischen Funktionenkalküls *Monatshefte für Mathematik und Physik* **37** 349-360 (1930). Reprinted in Feferman, S, ed. Gödel Collected Works, volume 1, publications 1929-1936, Oxford, p.102-122 (even numbers) original; p.103-123 (odd numbers) translators Bauer-Mengelberg, Stefan, & Heijenoort, Jean van (1986).
12. Gödel, Kurt, Über formal unentscheidbare Sätze der Principia Mathematica und verwandter Systeme, I. *Monatshefte für Mathematik und Physik* **38** 173-198 (1931): translated in Jean van Heijenoort, *From Frege to Gödel: A Source Book on Mathematical Logic, 1879-1931*, Harvard (1967).
13. Green, R M, *Spherical Astronomy*, Cambridge (1985).
14. Heather, M A, The Reliability of Ancient Eclipse Records, *Geophys J R astr Soc* **15** 549-550 (1968).
15. Heather, M A, & Rossiter, B N, Locality, Weak or Strong Anticipation and Quantum Computing I. Non-locality in Quantum Theory, *International Journal Computing Anticipatory Systems* **13** 307-326 (2002).
16. Heather, Michael, & Rossiter, Nick, The Relativism of Theories of Relativity, *Physical Interpretations of Relativity Theory-X* Imperial College, University of London, 8-11 September 5pp (2006).
17. Husserl, E, *Logischen Untersuchungen: Prolegomena zur reinen Logik I* (1900/1901); Logical Investigations: Prolegomena to Pure Logic, ed D Moran, London-New York, Routledge **I** p.159 (2001).
18. Mac Lane, *Categories for the Working Mathematician*, 2nd ed, Springer (1998).
19. *National Semiconductor, Clock Conditioner Owner's Manual*, winter 2006, [http://www.national.com/appinfo/interface/files/clk\\_conditioner\\_owners\\_manual.pdf](http://www.national.com/appinfo/interface/files/clk_conditioner_owners_manual.pdf) (2006).
20. Rossiter, B Nick, & Heather, M A, Data Structures in Natural Computing: Databases as Weak or Strong Anticipatory Systems, *CASYS'03, Sixth Int Conf*, Liège, Belgium, AIP Conf Proc **718** 392-405 (2004).
21. Rossiter, N, Heather, M, & Sisiaridis, D, Process as a World Transaction, *Proc ANPA* **27** 122-157 (2006).
22. Russell, B, *The Principles of Mathematics* 2nd ed (1937).
23. Schlosshauer, Maximilian, *Decoherence and the Quantum-to-Classical Transition*, Springer (2007).
24. Smart, W M, *Foundations of Astronomy* Longmans, Green (1942).
25. Smart, W M, *Textbook on Spherical Astronomy* revised by R M Green, Cambridge (1977).
26. Stephenson, F Richard, *Historical Eclipses and Earth's Rotation* Cambridge (1997).
27. Wadler, Philip, The Marriage of Effects and Monads, *Proc Third ACM SIGPLAN Int Conf Functional Prog* 63-74 (1998).
28. Whitehead, Alfred North, *Process and Reality: An Essay in Cosmology*, Macmillan, New York (1929); corrected edition, edd D R Griffin, D W. Sherburne, New York, The Free Press (1978).